

Apple

ColorSync Display



User's manual



 Apple Computer, Inc.

© 1997 Apple Computer, Inc. All rights reserved.

Under the copyright laws, this manual may not be copied, in whole or in part, without the written consent of Apple. Your rights to the software are governed by the accompanying software license agreement.

The Apple logo is a trademark of Apple Computer, Inc., registered in the U.S. and other countries. Use of the “keyboard” Apple logo (Option-Shift-K) for commercial purposes without the prior written consent of Apple may constitute trademark infringement and unfair competition in violation of federal and state laws.

Every effort has been made to ensure that the information in this manual is accurate. Apple is not responsible for printing or clerical errors.

Apple Computer, Inc.
1 Infinite Loop
Cupertino, CA 95014-2084
408-996-1010
<http://www.apple.com>

Apple, the Apple logo, AppleCD, ColorSync, the ColorSync logo, LaserWriter, Mac, Macintosh, Macintosh Quadra, PlainTalk, and PowerBook are trademarks of Apple Computer, Inc., registered in the U.S. and other countries.

Finder and OneScanner are trademarks of Apple Computer, Inc.

Adobe, Acrobat, Adobe Illustrator, Photoshop, and PostScript are trademarks of Adobe Systems Incorporated or its subsidiaries and may be registered in certain jurisdictions.

Helvetica and Times are registered trademarks of Linotype-Hell AG and/or its subsidiaries.

NuBus is a trademark of Texas Instruments.

PANTONE®, PANTONE MATCHING SYSTEM®, PANTONE Process Color System®, and other Pantone, Inc. trademarks are the property of Pantone, Inc. Portions © Pantone, Inc. 1995.

PowerPC is a trademark of International Business Machines Corporation, used under license therefrom.

Trinitron is a trademark of Sony Corporation, registered in the U.S. and other countries.

Simultaneously published in the United States and Canada.

Other products and company names mentioned herein may be trademarks of their respective companies. Mention of third-party products is for informational purposes only and constitutes neither an endorsement nor a recommendation. Apple assumes no responsibility with regard to the performance or use of these products.



Contents

Communications regulation information for ColorSync Display 17" (16.1" VIS) vi
Communications regulation information for ColorSync Display 20" (19" VIS) viii

1 Setting Up Your Monitor 1

Important safety and cleaning instructions 1
What about electromagnetic emissions? 3
Getting ready to set up your ColorSync Display 4
 Your ColorSync Display at a glance 5
Do you need to install a video card? 6
 Mac OS–based computers 7
 Windows-based computers 7
Choosing a good location for your monitor 7
Positioning the monitor 8
Connecting the monitor to your computer 9
 Connecting the power cord 10
 Connecting the monitor cable to a Mac OS–based computer 10
 Connecting the monitor cable to a Windows-based computer 13
 Connecting a Mac OS–based computer keyboard and mouse to
 your monitor 14
Using more than one monitor 15
Turning the monitor on 16
 Using the monitor with Windows-based computers 17

| | |
|---|-----------|
| Finding answers | 18 |
| Obtaining online support and updated Apple software | 18 |
| What to do next | 19 |
| Mac OS–based computers | 19 |
| Windows-based computers | 19 |
| 2 Installing and Using Apple Displays Software | 21 |
| Installing Apple Displays software | 21 |
| Learning about Apple Displays software with System 7.5 or later | 24 |
| Tips for using Monitors & Sound Guide | 25 |
| Screen controls at a glance | 26 |
| About the Monitors & Sound control panel | 27 |
| Opening Monitors & Sound | 27 |
| Monitors & Sound buttons at a glance | 28 |
| Tips for using Apple Displays software | 29 |
| Using the Control Strip | 30 |
| Using DigitalColor Meter | 31 |
| Opening DigitalColor Meter | 31 |
| Specifying colors using the PANTONE MATCHING SYSTEM® | 32 |
| Conserving energy | 33 |
| Setting up Energy Saver | 33 |
| What happens after you turn on the energy-saving feature? | 34 |
| Using Energy Saver with a screen saver | 34 |
| 3 Using Your Monitor With Windows-Based Computers | 35 |
| Installing ColorSync Display setup information for Windows | 36 |
| Screen controls at a glance | 37 |
| Using onscreen controls | 38 |
| Adjusting screen geometry | 39 |
| Width | 39 |
| Height | 39 |

| | |
|---|-----------|
| Pincushion | 39 |
| Vertical Shift | 39 |
| Horizontal Shift | 40 |
| Rotate | 40 |
| Default | 40 |
| Adjusting color settings and other features | 40 |
| Color Temperature | 41 |
| Overscan | 41 |
| Scan Rate | 41 |
| Degauss | 41 |
| Adjusting convergence | 42 |
| Vertical | 42 |
| Horizontal | 42 |
| 4 Tips and Troubleshooting | 43 |
| Care and cleaning | 43 |
| Protecting your monitor from theft | 44 |
| Troubleshooting common problems | 44 |
| Monitor power and screen appearance | 45 |
| Monitors & Sound control panel for Mac OS–based computers | 50 |
| Appendix A Using ColorSync Software | 55 |
| The problem that ColorSync software solves | 55 |
| How ColorSync software works | 56 |
| Setting up ColorSync software | 58 |
| Setting the ColorSync System Profile | 59 |
| Setting other ColorSync profiles | 60 |
| Tips for best results | 60 |
| Appendix B Technical Information | 63 |

Communications regulation information for ColorSync Display 17" (16.1" VIS)

FCC declaration of conformity

This device complies with part 15 of the FCC rules. Operation is subject to the following two conditions: (1) This device may not cause harmful interference, and (2) this device must accept any interference received, including interference that may cause undesired operation. See instructions if interference to radio or television reception is suspected.

Radio and television interference

The equipment described in this manual generates, uses, and can radiate radio-frequency energy. If it is not installed and used properly—that is, in strict accordance with Apple's instructions—it may cause interference with radio and television reception.

This equipment has been tested and found to comply with the limits for a Class B digital device in accordance with the specifications in Part 15 of FCC rules. These specifications are designed to provide reasonable protection against such interference in a residential installation. However, there is no guarantee that interference will not occur in a particular installation.

You can determine whether your computer system is causing interference by turning it off. If the interference stops, it was probably caused by the computer or one of the peripheral devices.

If your computer system does cause interference to radio or television reception, try to correct the interference by using one or more of the following measures:

- Turn the television or radio antenna until the interference stops.
- Move the computer to one side or the other of the television or radio.
- Move the computer farther away from the television or radio.
- Plug the computer into an outlet that is on a different circuit from the television or radio. (That is, make certain the computer and the television or radio are on circuits controlled by different circuit breakers or fuses.)

If necessary, consult an Apple-authorized service provider or Apple. See the service and support information that came with your Apple product. Or, consult an experienced radio/television technician for additional suggestions.

IMPORTANT Changes or modifications to this product not authorized by Apple Computer, Inc., could void the FCC Certification and negate your authority to operate the product.

This product was tested for FCC compliance under conditions that included the use of Apple peripheral devices and Apple shielded cables and connectors between system components. It is important that you use Apple peripheral devices and shielded cables and connectors between system components to reduce the possibility of causing interference to radios, television sets, and other electronic devices. You can obtain Apple peripheral devices and the proper shielded cables and connectors through an Apple-authorized dealer. For non-Apple peripheral devices, contact the manufacturer or dealer for assistance.

Responsible party: Robert Steinfeld, Apple Computer, Inc., 1 Infinite Loop, Cupertino, CA 95014-2084, 408-974-2618.

Communications regulation information for ColorSync Display 17" (16.1" VIS) (continued)

Industry Canada statement

This Class B device meets all requirements of the Canadian interference-causing equipment regulations.

Cet appareil numérique de la Class B respecte toutes les exigences du Règlement sur le matériel brouilleur du Canada.

VCCI Class 2 statement

情報処理装置等電波障害自主規制について

この装置は、情報処理装置等電波障害自主規制協議会(VCCI)の基準に基づく第二種情報技術装置です。この装置は、家庭環境で使用することを目的としていますが、この装置がラジオやテレビジョン受信機に近接して使用されると、受信障害を引き起こすことがあります。

取扱説明書に従って正しい取り扱いをしてください。

Communications regulation information for ColorSync Display 20" (19" VIS)

FCC statement

This equipment has been tested and found to comply with the limits for a Class A digital device, pursuant to Part 15 of FCC rules. These limits are designed to provide reasonable protection against radio interference when the equipment is operated in a commercial environment. This equipment generates, uses, and can radiate radio-frequency energy, and if not installed and used in accordance with Apple's instructions, may cause interference to radio communications. Operation of this equipment in a residential area is likely to cause such interference, in which case the user will be required to correct the interference at his or her own expense.

IMPORTANT Changes or modifications to this product not authorized by Apple Computer, Inc., could void the FCC verification and negate your authority to operate the product.

This product was tested for FCC compliance under conditions that included the use of Apple peripheral devices and Apple shielded cables and connectors between system components. It is important that you use Apple peripheral devices and shielded cables and connectors between system components to reduce the possibility of causing interference to radios, television sets, and other electronic devices. You can obtain Apple peripheral devices and the proper shielded cables and connectors through an Apple-authorized dealer. For non-Apple peripheral devices, contact the manufacturer or dealer for assistance.

Industry Canada statement

This Class A device meets all requirements of the Canadian Interference-Causing equipment regulations.

Cet appareil numérique de la Class A respecte toutes les exigences du Règlement sur le matériel brouilleur du Canada.

CISPR 22 statement

IMPORTANT This is a Class A product. In a domestic environment this product may cause radio interference, in which case the user may be required to take adequate measures.

VCCI Class 1 statement

情報処理装置等電波障害自主規制について

この装置は、情報処理装置等電波障害自主規制協議会 (VCCI) の基準に基づく第一種情報技術装置です。この装置を家庭環境で使用すると電波妨害を引き起こすことがあります。この場合には使用者が適切な対策を講ずるよう要求されることがあります。

1

Setting Up Your Monitor



The ColorSync Display is a Trinitron® color monitor that supports a variety of resolutions and features advanced controls for accurate color rendering. The monitor works with Mac OS–based and Windows-based computers.

This chapter reviews important safety information and explains how to set up and connect your monitor to your computer. If you purchased a new computer along with your monitor, refer to the setup instructions that came with your computer in addition to the instructions in this manual.

Important safety and cleaning instructions

WARNING Do not clean your monitor screen with a cleaner that contains alcohol or acetone. You might damage the screen. For more information about cleaning your monitor, see “Care and Cleaning” in Chapter 4.

For your own safety and that of your equipment, always take the following precautions.

Disconnect the monitor's power plug (by pulling the plug, not the cord) if any of the following conditions exists:

- the power cord or plug becomes frayed or otherwise damaged
- you spill something into the case
- your monitor is exposed to rain or any other excess moisture
- your monitor has been dropped or the case has been otherwise damaged
- you suspect that your monitor needs service or repair
- you want to clean the case (use only the recommended procedure described in "Care and Cleaning" in Chapter 4)

IMPORTANT The only way to disconnect power completely is to unplug the monitor's power cord. Make sure at least one end of the power cord is within easy reach so that you can unplug the monitor when you need to.

Be sure that you always:

- Keep your monitor away from sources of liquids, such as washbasins, bathtubs, shower stalls, beverages, and so on.
- Avoid setting anything on top of the monitor (such as a book or cup). The monitor could overheat and be damaged.
- Keep the monitor's vents free from obstruction.
- Protect your monitor from dampness or wet weather, such as rain, snow, and so on.
- Read all the installation instructions carefully before you plug your monitor into a power source.
- Keep these instructions handy for reference by you and others.
- Follow all instructions and warnings dealing with your system.

WARNING Never remove the cover from the monitor or you may come in contact with hazardous voltage levels capable of causing serious injury and possibly death.

WARNING Electrical equipment may be hazardous if misused. Operation of this product, or similar products, must always be supervised by an adult. Do not allow children access to the interior of any electrical product, and do not permit them to handle any cables.

What about electromagnetic emissions?

There has been recent public discussion of the possible health effects of prolonged exposure to extremely low frequency (ELF) and very low frequency (VLF) electromagnetic fields. Such fields are associated with electromagnetic sources such as television sets, electrical wiring, and some household appliances—as well as computer monitors.

Apple has reviewed scientific reports and sought the counsel of government regulatory agencies and respected health organizations. Based on the prevailing evidence and opinions, Apple believes that the electric and magnetic fields produced by computer monitors do not pose a health risk.

In response to those customers who wish to reduce their exposure to electromagnetic fields, Apple has lowered the emission levels of Apple monitors. We are also actively encouraging further scientific research so we can continue to promote the health and safety of our customers and employees.

Getting ready to set up your ColorSync Display

Before you set up your monitor, make sure you have easy access to the following items that came with your monitor:

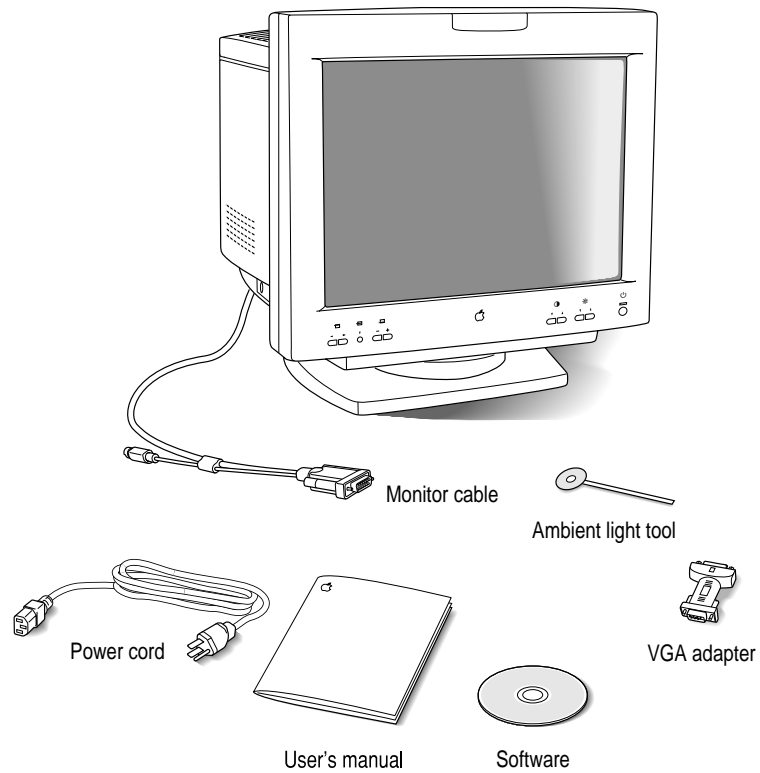

Note: Your power cord may look different from the one pictured.

Your ColorSync Display at a glance

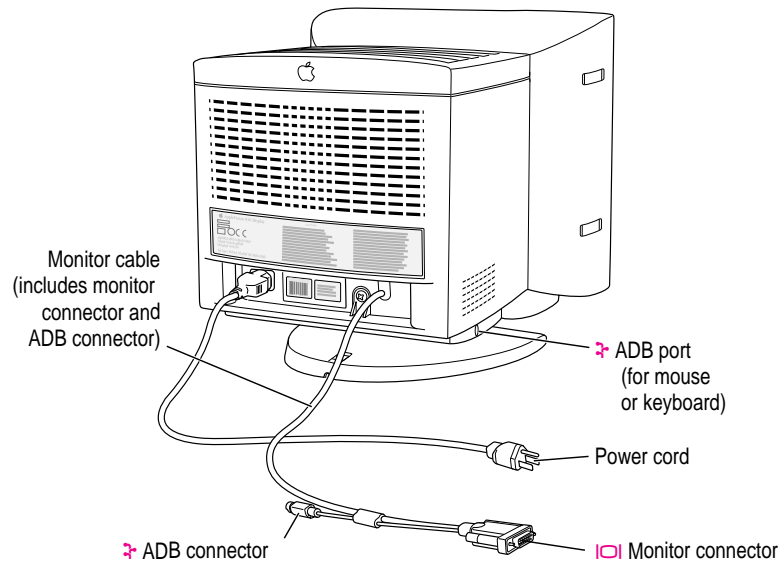
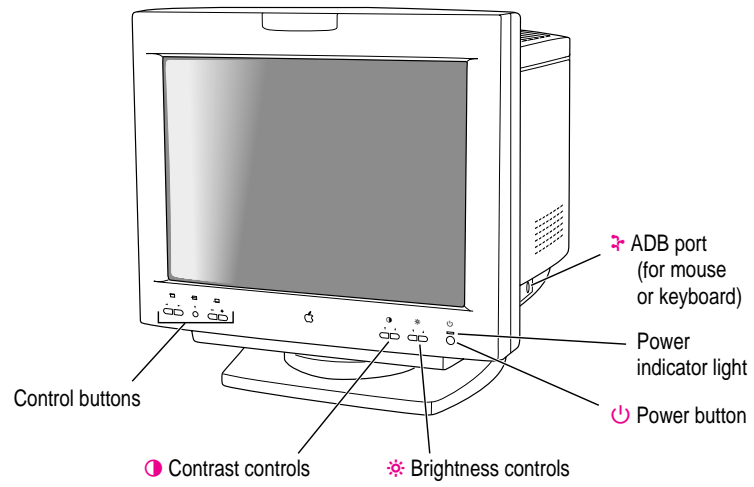

Do you need to install a video card?

The monitor is preadjusted and supports the following scan ranges:

- horizontal scan rate of 30–80 kilohertz (ColorSync Display 17" [16.1" VIS]);
30–94 kilohertz (ColorSync Display 20" [19" VIS])
- vertical refresh rate of 40–120 hertz (ColorSync Display 17" [16.1" VIS]);
48–120 hertz (ColorSync Display 20" [19" VIS])

In addition, the monitor works at the following VESA (Video Electronics Standards Association) standard modes:

| Resolution | Vertical refresh rate (hertz) | |
|-------------|-------------------------------|---------------|
| | 17" (16.1" VIS) | 20" (19" VIS) |
| 640 x 480 | 60–85 | 60–85 |
| 800 x 600 | 56–85 | 56–85 |
| 1024 x 768 | 60–85 | 60–85 |
| 1152 x 870 | 60–75 | — |
| 1280 x 1024 | 60–75 | 75–85 |
| 1600 x 1200 | 60 | 75 |

The ColorSync Display 20" (19" VIS) monitor also works at the following Macintosh standard modes:

| Resolution | Vertical refresh rate (hertz) |
|------------|-------------------------------|
| 832 x 624 | 75 |
| 1152 x 870 | 75 |

These are preassigned resolutions; your computer may support other resolutions within this range. See the manual that came with your computer or video card to determine which resolutions are supported.

For more information on factory-preadjusted settings and other technical information about your monitor, see Appendix B, “Technical Information.”

To use your monitor, you need compatible video circuitry built into your computer or a compatible video card installed in your computer.

Note: The Apple 8•24, Apple 8•24GC, and most NuBus™ video cards are not compatible with your monitor. In addition, some third-party PCI cards are not fully compatible with your monitor.

Mac OS–based computers

If you are not sure whether your computer has appropriate built-in video capability, check with an Apple-authorized dealer or service provider. If your computer does not have the video capability necessary to use your monitor, you need to purchase a video card. (Video cards for Mac OS–based computers are available from an Apple-authorized dealer or service provider.)

Install the video card before you connect the monitor to your computer. To install a video card in one of the expansion slots inside your computer, see the manual that came with your computer or video card.

Windows-based computers

Your monitor works with most Windows-based computers equipped with VGA (Video Graphics Array) or greater capability. You may need to install a video card to use the monitor with your computer. For more information, see the manuals that came with your computer.

If you don't use a preassigned resolution, you'll need to adjust screen geometry to match the new resolution. For more information, see "Adjusting Screen Geometry" in Chapter 3.

Choosing a good location for your monitor

Here are some key factors to consider when determining where to place your monitor:

- Be sure that the desk or table can support the monitor's weight—approximately 50 pounds (23 kilograms) for the 17" display (16.1" VIS); approximately 67 pounds (30 kilograms) for the 20" display (19" VIS).
- Make sure that the power cord and monitor cable will easily reach from the back of the monitor to your computer and wall outlet.
- The monitor cable should be unobstructed when you swivel and tilt the monitor, so allow at least 7 inches (17.5 cm) of clearance in the back. If you don't allow enough clearance, the monitor connector might be damaged when the cable hits an obstruction.

Note: After you set up and configure the monitor, adjust the image and colors on the screen to match your environment. For example, in a bright room, contrast is usually best set at maximum; in a dim room, lower contrast is usually more comfortable. See Chapter 2, “Installing and Using Apple Displays Software,” for more information about making screen and color adjustments using Apple Displays software for Mac OS–based computers. See Chapter 3, “Using Your Monitor With Windows-Based Computers,” for information about onscreen controls for adjusting screen image and color for Windows-based computers.

Connecting the monitor to your computer

Follow these steps to connect your monitor to your computer.

IMPORTANT Before you connect any cords or cables, make sure your computer is turned off.

WARNING This equipment is intended to be electrically grounded. Your monitor may be equipped with a three-wire grounding plug—a plug that has a third (grounding) pin. This plug will fit only a grounded AC outlet. This is a safety feature. If you are unable to insert the plug into the outlet because the outlet is not grounded, contact a licensed electrician to replace the outlet with a properly grounded outlet. Do not defeat the purpose of the grounding plug!

Connecting the power cord

- 1 **Connect the socket end of the power cord to the power cord receptacle on the back of the monitor.**

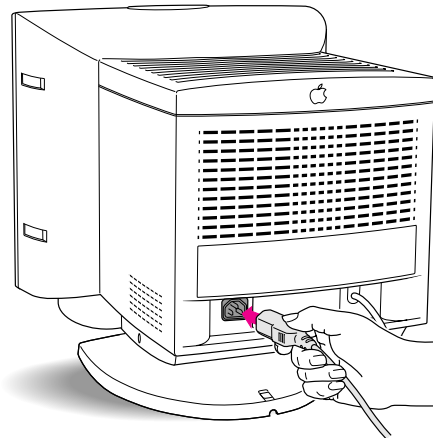

- 2 **Plug the other end of the power cord into a grounded outlet or power strip.**

Note: You may have a power jumper cord instead of a power wall cord. In this case, plug the power jumper cord into the power socket on the back of your computer.

Connecting the monitor cable to a Mac OS–based computer

Connecting to a standard monitor port

To realize the full capability of your monitor, you must connect it to the video *and* ADB ports on your computer. The monitor cable is a split cable with two connectors, one for video and one for the Apple Desktop Bus (ADB).

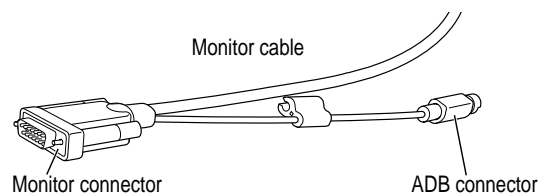

- 1 Plug the monitor connector on the monitor cable into the monitor port (marked by ) on the back of your computer.**

If your computer has more than one monitor port, see the manual that came with your computer for information on choosing the correct port.

If you installed a video card in your computer, connect the monitor connector on the monitor cable to the video card's port. For more information about installing video cards, see the manual that came with your computer or video card.

- 2 Tighten the thumbscrews on the connection.**



You can prevent bad connections and accidental damage by tightening the thumbscrews. Do not overtighten the thumbscrews; you might strip the threads.

- 3 Plug the ADB connector on the monitor cable into an ADB port (marked by ) on the back of your computer.**

Make sure the ADB connector is attached firmly.

IMPORTANT The ADB connector is not optional; it's needed for your Mac OS–based computer to work correctly with your monitor. If not connected properly, extended resolutions and ColorSync software controls will not be available.

If you have only one ADB port on the back of your computer and you're already using it for your keyboard and mouse, unplug the keyboard and mouse and connect them directly to your monitor. For more information, see “Connecting a Mac OS–Based Computer Keyboard and Mouse to Your Monitor” later in this chapter.

WARNING Make sure you don't plug the ADB connector into an S-video port (marked by  or ) by mistake. The ports are the same size, and it's easy to mistake one for the other. It may cause electrical damage to your computer or monitor.

IMPORTANT When connecting ADB cables, be sure to align the symbol  on the connector with the same symbol on the port. If you force a connector the wrong way, you will damage it.

Connecting the monitor cable to various video connectors

To connect the monitor to a high-density port (45-pin port) instead of a standard monitor port (15-pin port), you need to use an adapter. This adapter is usually provided with your computer. If you don't have one, you can purchase an adapter (Apple part number M2681LL/A) from an Apple-authorized dealer.

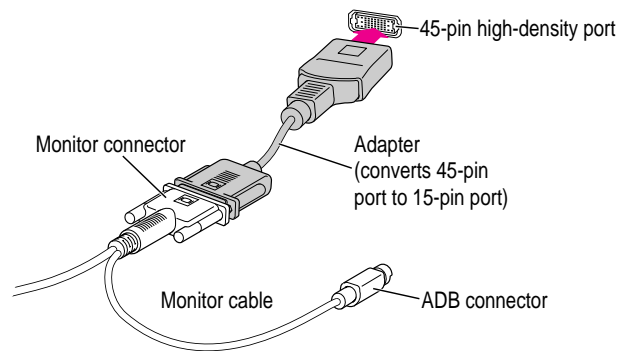

Other video connectors, such as PowerBook adapters, can also connect to your monitor port with special adapters. For more information, see the manual that came with your computer.

Note: If your Mac OS–based computer came with a VGA adapter for connecting monitors, use it instead of the one shipped with your ColorSync monitor.

Connecting the monitor cable to a Windows-based computer

Although the monitor cable is a split cable with two connectors, you will use only the monitor connector with your computer.

- 1 Connect the VGA adapter to the monitor connector (marked by ) on the monitor cable.**

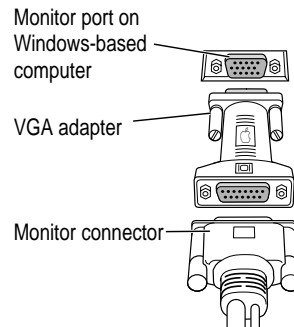

- 2 Tighten the thumbscrews on the connection.**

You can prevent bad connections and accidental damage by tightening the thumbscrews. Do not overtighten the thumbscrews; you might strip the threads.

- 3 Connect the VGA adapter end of the monitor cable to the monitor port on the back of your computer.**

If you installed a video card in your computer, connect the monitor cable (with the VGA adapter attached to it) to the video card's port. For more information about installing video cards, see the manual that came with your computer or video card.

- 4 Tighten the thumbscrews on the connection.**
- 5 Leave the ADB connector on the monitor cable unplugged.**

The ADB connector is for Mac OS–based computers only. Use the clip on the monitor cable to move the ADB connector out of the way.

Connecting a Mac OS–based computer keyboard and mouse to your monitor

If you wish, you can plug your keyboard and mouse directly into the monitor, rather than into the back of your computer. There is one ADB port on each side of the monitor for your keyboard and mouse (or any other ADB device).



IMPORTANT Always be sure your computer is shut down before you plug in or disconnect ADB cables.

- 1 Make sure the ADB connector on the monitor cable is plugged into an ADB port (marked by ) on the back of your computer.**

IMPORTANT The ADB connector is not optional; it's needed for your Mac OS–based computer to work correctly with your monitor. If not connected properly, extended resolutions and Apple Displays software controls will not be available.

For more information, see “Connecting the Monitor Cable to a Mac OS–Based Computer” earlier in this chapter.

- 2 If necessary, unplug the keyboard or mouse cable from the ADB connector on the back of your computer.**
- 3 Decide how you want to connect the keyboard and mouse.**

For example, you can connect your mouse cable to your keyboard and then connect the keyboard to one of the ADB ports (marked by ) on either side of the monitor stand. Or, if you prefer, you can plug your keyboard and mouse cables into the ADB ports (marked by ) on either side of the monitor stand.

- 4 Connect your keyboard and mouse cables to the monitor's ADB ports (marked by ) according to your preference.**

Using more than one monitor

If your computer has expansion slots, you can use your monitor with one or more additional monitors connected to your computer. You may need a video card for each additional monitor you are using. See the manual that came with your computer for more information.

If your Mac OS–based computer has one ADB port, you can still connect two ColorSync monitors. You'll need a special cable to split the ADB connector cable into two parts.



IMPORTANT Make sure you use an Apple *shielded* connector cable. Most third-party ADB splitter cables are not shielded and will not work properly with your ColorSync monitor. (You may experience more radio interference with an unshielded connector cable.)

Turning the monitor on

To turn on the monitor for the first time:

- 1 Plug in the computer's power cord.**
- 2 Press the power button on the monitor.**

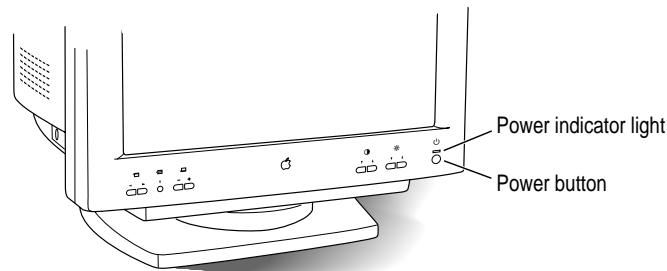

If you plug your monitor directly into your computer, no power indicator light goes on until you start up your computer. If you plug your monitor into a wall outlet, the monitor's amber power indicator light goes on. When you start up your computer, the indicator light turns green.

- 3 Start up your computer and wait a few seconds.**

The green power indicator light goes on. If the power indicator light does not go on, press the monitor's power button again. If this doesn't work, make sure you've connected the monitor cable and power cord properly. (See "Connecting the Monitor to Your Computer" earlier in this chapter.) Also, make sure your computer is turned on and no energy-saving or screen-saving features are active. The power indicator light on the 20-inch (19-inch VIS) monitor is amber when an energy-saving program is on; it is off on the 17-inch (16.1-inch VIS) monitor in energy-saving mode.

For Mac OS–based computers, you must install the Apple Displays software that came with your monitor *before* adjusting the screen with the front panel buttons and using other monitor features. For more information on Apple Displays software installation and Energy Saver, see Chapter 2, "Installing and Using Apple Displays Software."

WARNING Before making any screen or sound adjustments, install the Apple Displays software on your Mac OS–based computer. Using software other than the new Apple Displays software that came with your monitor could damage your monitor.

Using the monitor with Windows-based computers

In most cases, once you turn on the monitor, you will not have to make any adjustments to the screen image. If necessary, you can adjust or fine-tune the image to suit your personal preference. For more information about adjusting the screen image, see Chapter 3, “Using Your Monitor With Windows-Based Computers.”

To change resolutions on your monitor, see the manuals that came with your operating software or video card.

Note: The *Apple Displays Software* CD-ROM disc includes a ColorSync Display setup file for Windows-based users. See Chapter 3, “Using Your Monitor With Windows-Based Computers,” for installation instructions.

Finding answers

When you have questions about using your monitor, there are several places you can look for answers.

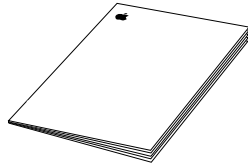

This manual

Use this manual to set up your monitor, install Apple Displays software for Mac OS–based computers, install ColorSync Display setup information and use onscreen controls for Windows-based computers, and find solutions to common problems.



Apple Guide for Mac OS–based computers

If you need help or experience a problem while using the Apple Displays software, open the Guide (⌘) menu and choose Macintosh (or Mac OS) Guide or Monitors & Sound Guide. The Guide menu is the main source for information about the Apple Displays software and your Mac OS–based computer. See Chapter 2 for more information.

Obtaining online support and updated Apple software

Apple technical support information and software updates are available from many online services. You can get troubleshooting and other important information by using these services. You can also get the latest versions of Apple software, including most printer drivers, system enablers, and updates to utilities and networking and communications software.

Support information and Apple software updates are available via Apple's World Wide Web sites:

- <http://www.info.apple.com>
- <http://www.support.apple.com>

What to do next

Mac OS–based computers

Go to the next chapter for information about installing and using Apple Displays software.

Windows-based computers

Go to Chapter 3, “Using Your Monitor With Windows-Based Computers,” for information on installing ColorSync Display setup information and using the control buttons to open onscreen menus for screen image adjustments.

2

Installing and Using Apple Displays Software



This chapter explains how to install Apple Displays software on your Mac OS–based computer and provides an overview of software features. If you’re using the monitor with a Windows-based computer, see Chapter 3, “Using Your Monitor With Windows-Based Computers.”

Installing Apple Displays software

To install Apple Displays software on a Mac OS–based computer, follow these steps:

1 Make sure you have System 7.5 or later installed.

You need a Mac OS–based computer running System 7.5 or later to use the software. If you don’t have System 7.5 or later, contact an Apple-authorized dealer or service provider.

Note: You must connect your monitor to a computer with a 68040 processor or PowerPC™. The monitor does not work with computers that have been upgraded to a 68040 processor from earlier processors, such as a 68030 processor.

2 Insert the *Apple Displays Software* CD-ROM disc into the computer’s CD-ROM drive.

The CD icon appears on the desktop.

Note: If you don’t have a CD-ROM disc drive, you can order a set of floppy disks of the Apple Displays software. See the service and support information that came with your monitor for more information.



- 3 Double-click the CD icon to see what's on the CD-ROM disc.**

The Apple Displays Software CD window opens.

- 4 Double-click the folder that contains your language preference.**

For example, if you'd like to install Apple Displays software in English, double-click the English folder.

- 5 Double-click the Apple Displays Software folder.**

- 6 Double-click the Apple Displays Read Me file and read the document.**

The Apple Displays Read Me file contains important information about the applications included with your Apple Displays software. It also provides a list of installed software for your reference.

- 7 Choose Quit from the File menu when you're finished reading.**

- 8 Double-click the Apple Displays Installer icon to start the Installer program.**

A welcome screen appears.

- 9 Click Continue.**

The software license agreement dialog box appears.

Note: Be sure you're acting within the terms of the software license agreement before you agree to install this software on your computer. The license agreement specifies how many copies of the program you can make for yourself and others.

- 10 Click Agree once you've read and agreed to the terms in the document.

The Install Apple Displays Software dialog box appears.

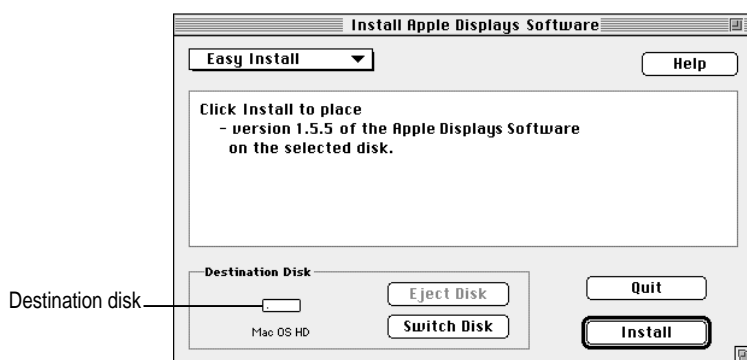

- 11 Make sure the destination disk named is the startup disk of your computer. If it isn't, click Switch Disk until you see the right name.
- 12 Select Easy Install; then, click Install.

The Installer takes a few moments to calculate what needs to be done and then begins to copy files. If you are running other applications, a message appears telling you to quit any open applications. Click Continue to quit the applications and continue with the installation.

Note: Make sure you use the Installer to install the software. Do not install the software by dragging files.

- 13 Follow the instructions on the screen until the installation is complete.

IMPORTANT The Installer checks to make sure you have the system software you need to use the monitor. If you're missing anything, a message tells you what you need. You won't be able to install the software until you correct the problem. If a dialog box says you don't have the correct system software, you can purchase a new version from an Apple-authorized dealer.

After the installation, the Installer tells you to restart your computer.

- 14 Click Restart.

The software is now installed and the monitor is ready for use.

IMPORTANT If you reinstall system software on your computer, you must reinstall the Apple Displays software.

Note: If you press a control button under the screen on the left front of your monitor and do not see the Monitors & Sound control panel, you probably haven't set up your monitor correctly. Make sure the ADB connector on the monitor cable is connected directly to your computer's ADB port. See Chapter 1, "Setting Up Your Monitor," for more information.

Learning about Apple Displays software with System 7.5 or later

This section explains how to open Monitors & Sound Guide for information about using Apple Displays software with your monitor.

The Monitors & Sound Guide is your main source of information about Apple Displays software. The Guide menu is identified by a question mark (Ⓜ) in the upper-right corner of the screen.

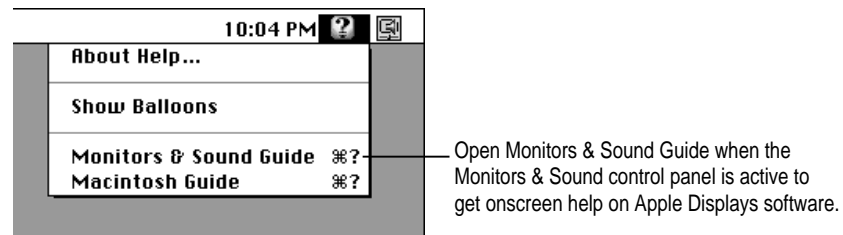

To open Monitors & Sound Guide, make sure your Monitors & Sound control panel is active. Then, click the Guide (Ⓜ) icon on the top-right corner of the control panel to open Monitors & Sound Guide or choose Monitors & Sound Guide in the Guide (Ⓜ) menu at the top of your screen.

Macintosh (or Mac OS) Guide also contains the same information about the Apple Displays software as well as other information about using your computer. Macintosh Guide is available while you're in the Finder.

Monitors & Sound Guide provides onscreen help on how to use Apple Displays software.

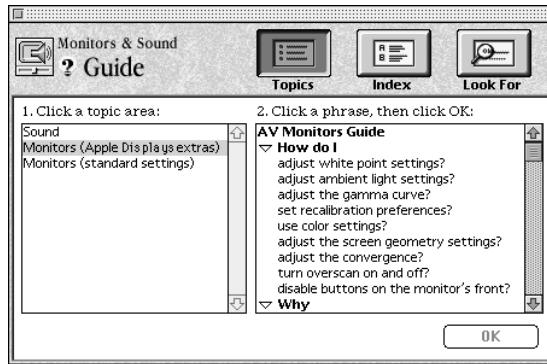

Monitors & Sound Guide provides information about the following topics: sound, monitors (Apple Displays extras), monitors (standard settings), and troubleshooting. Click the Topics button to open these topic areas and choose a topic. Then, select a question in the list and click OK to open detailed instructions.

Tips for using Monitors & Sound Guide

When you can't find the information you need

- In searching for help topics, use all three buttons at the top of the Guide's initial window: Topics, Index, and Look For.
- If you're in a series of steps and want to return to the list of help topics, click the button marked Topics in the Guide window.

When you can't see what's behind the Guide window

Guide windows stay in front of other windows on the screen so that your instructions are never covered.

- Drag a Guide window by its title bar to move it out of the way.
- Click the zoom box once to shrink a Guide window. (To expand the window, click the zoom box a second time.)

When you need more information about an instruction or term

- Click the “Huh?” button if it is available.
- If an unfamiliar word is underlined, click it to get a definition.

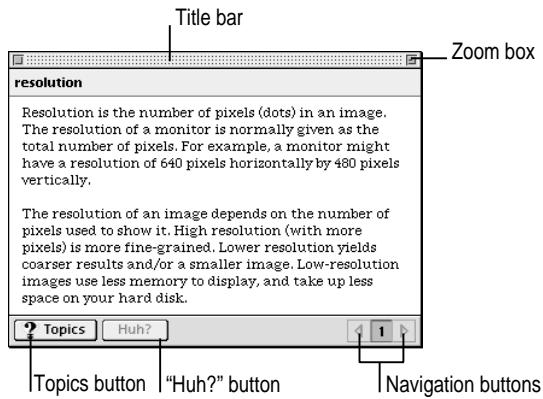

Screen controls at a glance

The buttons on the front of your monitor provide a quick way to adjust the screen image. In most cases, you won't need to adjust the screen image unless you make changes to screen resolution.

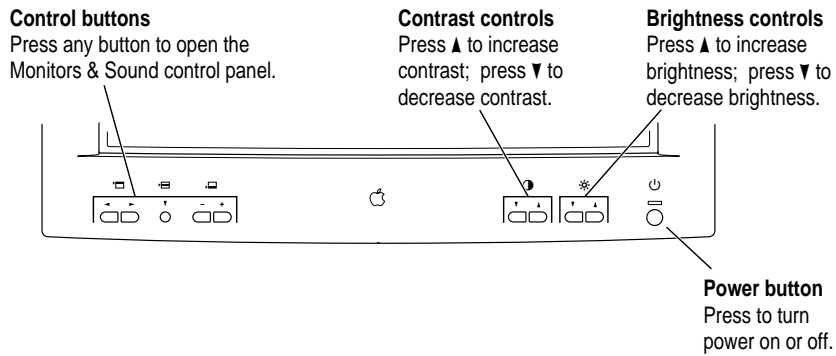

The Contrast and Brightness controls have an onscreen indicator that appears when you press a button on the front of your monitor. For example, pressing a Brightness control displays the Brightness indicator.

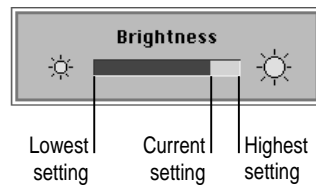

When you make an adjustment, the indicator bar moves to show the current setting. When you've finished making adjustments, the indicator disappears automatically.

About the Monitors & Sound control panel

The Monitors & Sound control panel allows you to control the way your computer displays images and processes sound. Because different computers have different capabilities, Monitors & Sound automatically adjusts itself based on the video and sound capabilities of the computer and monitor you're using. That's why the Monitors & Sound control panel shown in this manual may appear slightly different on your computer.

If you have more than one monitor attached to your computer, a separate Monitors & Sound control panel will appear on each one, allowing you to customize your settings for each monitor separately.

Opening Monitors & Sound

There are two ways to open the Monitors & Sound control panel:



- Choose Control Panels from the Apple () menu; then select Monitors & Sound.
- Press one of the control buttons under the screen on the left front of your monitor.

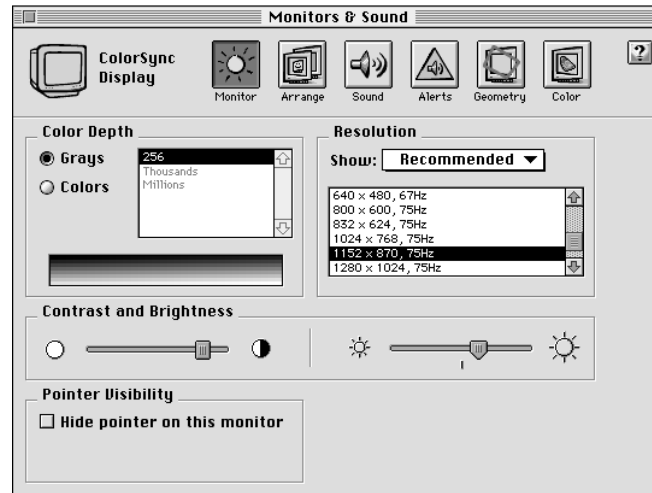

After a moment, the Monitors & Sound control panel appears on your screen.



Monitors & Sound buttons at a glance

The large buttons across the top of the Monitors & Sound control panel are used to select different options.

| Button | Description |
|---|--|
|  | Use the Monitor button to adjust color depth, resolution, contrast, and brightness settings. |
|  | Use the Arrange button to configure more than one monitor. This button appears on your screen if you have more than one video port on your computer. |
|  | Use the Sound button to adjust your computer system's sound. You can also set the volume and balance for speakers attached to your computer, choose sound input devices such as a microphone or CD player, and select sound output quality. |

| Button | Description |
|---|---|
|  | Use the Alerts button to change your computer's alert sound. |
|  | Use the Geometry button to change the image options for your monitor. You can change the size and shape of the screen image, adjust convergence, and turn overscan on and off. |
|  | Use the Color button to change color calibration, gamma curve, white point, and ambient light settings, and to import or export a ColorSync profile. (For more information on ColorSync software, see Appendix A.) |

Tips for using Apple Displays software

- For best results, recalibrate your monitor after changing the color settings. For example, color adjustment changes don't take effect until you click Recalibrate. You can choose to have your monitor recalibrate automatically whenever you change the settings. Click the Color button. Then click Preferences. After selecting your recalibration preferences, click Save.
- To use the default settings shipped with your monitor, click the Geometry button. When the Geometry window opens, click the Factory Settings option. To use the color default settings, click the Color button. When the Color window opens, double-click Factory Defaults in the Saved Settings menu.
- Red, green, and blue signals in your monitor overlay, or converge, to create the colors you see on your screen. If the convergence is not set properly, images or text on your screen may appear blurred, or you may get a "rainbow" effect in which several colors form the edges of images on the screen. If you move your monitor to another location, you may need to change the convergence to get a clear, distinct screen image. To adjust convergence, click the Convergence button in the Geometry window.
- When overscan is on, you may not be able to choose commands from the menus at the top of your monitor. If this occurs, you can't use a menu to open the Monitors & Sound control panel and turn overscan off. Instead, open Monitors & Sound by pressing a Control button on the front of your monitor.

- The ColorSync profile included with your monitor works with other device profiles to ensure the closest match possible between monitor color and printed color. See Appendix A, “Using ColorSync Software” for more information. To refine the color profile, you can use the Color window in the Monitors & Sound control panel to further adjust for your specific monitor and lighting conditions.
- To correct for ambient light conditions, the color depth on your monitor must be set to “Millions of Colors.” If you can’t set color depth to “Millions of Colors,” try changing to a lower screen resolution. Use the Color button to open color depth and resolution settings.

Note: References to AppleVision also apply to your ColorSync Display.

Using the Control Strip

When you turn on your monitor, a small pull tab appears in the lower-left corner of the screen. Click once on the pull tab to open it. This is called the *Control Strip*.

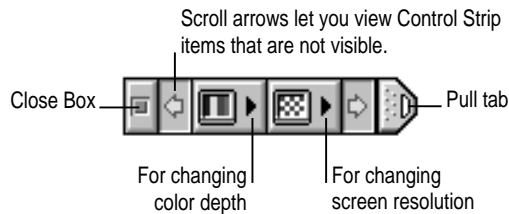

The Control Strip is a quick and easy way to make changes to the features you use most on your computer, such as screen resolution and color depth.

The Control Strip may look slightly different depending on the options on your computer. Move the pointer over the item you want to use and hold down the mouse button. A pop-up menu appears with a selection of choices.

Hold down the Option key and drag the Control Strip up or down the left or right side of the desktop. Release the Option key and mouse button when the Control Strip is located where you want it.

Using DigitalColor Meter

DigitalColor Meter and your monitor work together to identify colors on your screen based on the standard color gamuts defined by the Commission on Illumination (CIE).

DigitalColor Meter can also identify colors using the PANTONE® system. PANTONE is a color-simulation system used to specify ink colors for high-end printers. Colors are described using their printing ink formulation, which is identified by a specific PANTONE number. DigitalColor Meter performs color simulation and provides PANTONE numbers for coated (CVC), uncoated (UVC), and process (CVP) color samples. Use the PANTONE numbers when you have your work professionally printed to ensure that the printer will use colors similar to those displayed on your screen.

Finally, you can use DigitalColor Meter to identify the RGB (red, green, blue) values your computer uses to create colors.

Opening DigitalColor Meter

Choose DigitalColor Meter from the Apple () menu. (It was installed with your Apple Displays software.)

When you launch DigitalColor Meter, its window opens on your monitor.

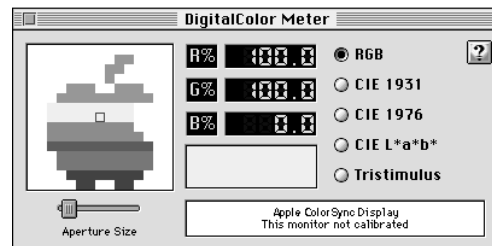

See DigitalColor Meter Guide (located in the Guide [?] menu when the DigitalColor Meter application is active) for more information on how to use DigitalColor Meter.

Specifying colors using the PANTONE MATCHING SYSTEM®

In some application programs, you can use Apple's Color Picker in conjunction with the PANTONE® Color Picker to specify PANTONE® colors. The PANTONE Color Picker extension is automatically installed along with the rest of the Apple Displays software.

For example, in a variety of applications, Apple's Color Picker is automatically launched when a new color needs to be specified. Often, a menu of several different color systems is available to choose from. When you select PANTONE, a dialog box appears.

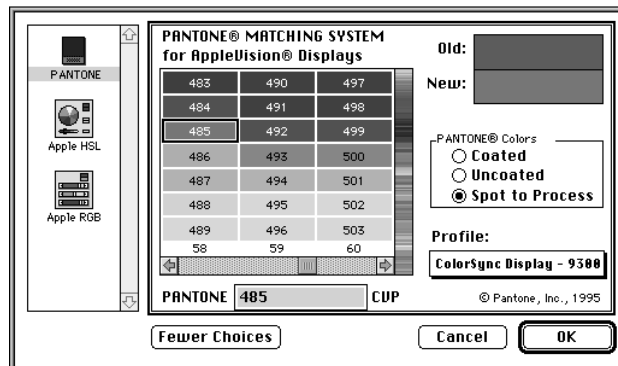

By selecting PANTONE matching colors, you are assured of a close match between what you see on your monitor and the printed version. PANTONE® Color Picker may look different on your computer.

If PANTONE colors are not available in the Color Picker menu, click the More Choices button; then select PANTONE.

Conserving energy

Use the Energy Saver control panel to tell the monitor whether to conserve energy after a specified period of inactivity.

You can use the control panel with your monitor or any other Apple monitor that complies with the United States Environmental Protection Agency's Energy Star program. (Look for the EPA Energy Star logo on the monitor box.)

Note: When you save energy, you save natural resources and reduce pollution. Although the ColorSync Display includes features that automatically save energy, you can increase the energy savings by turning the monitor off if you won't be using it for awhile—for example, overnight or over the weekend.

Setting up Energy Saver

To use the Energy Saver control panel, follow these steps:

- 1 **Open the Apple () menu and choose Energy Saver from the Control Panels folder.**

The Energy Saver control panel appears.

- 2 **Make the following choices in the control panel:**

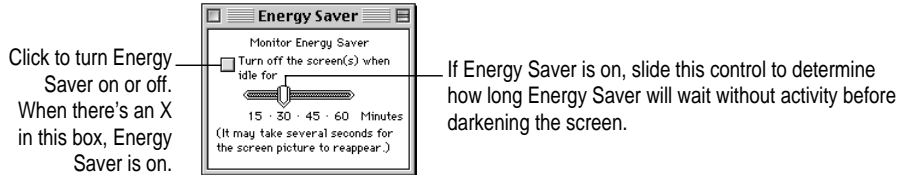

The Energy Saver control panel on your system may look slightly different from the one shown here. If you see a Show Details button, you can click it to specify separate timings for Display Sleep and Hard Disk Sleep. (Hard Disk Sleep saves energy by stopping the spin of the hard disk.)

- 3 **Close the control panel.**

IMPORTANT If you use Energy Saver, make sure you turn it off when you're doing disk-intensive tasks such as copying a large number of files, downloading large files from an online service, or printing a very large file. If Energy Saver is activated during a disk-intensive task, the task may be terminated prematurely and you may need to recopy or reprint a file.

What happens after you turn on the energy-saving feature?

When Energy Saver detects that you're not using the computer, it darkens the monitor screen and reduces the amount of energy it consumes. While the monitor is darkened, your computer is still working, but to avoid accidental changes, Energy Saver won't let anything you type or do with the mouse affect any of your work.

To "wake up" the monitor, press any key on the keyboard. Your computer beeps while the monitor is waking up—about 10 seconds—and you can begin work as soon as the computer stops beeping. (The beep volume cannot be adjusted; it is independent of all system sound controls.)

Using Energy Saver with a screen saver

Screen savers are applications you can purchase that put moving patterns on your monitor. Screen saver and Energy Saver applications prevent screen "burn-in." Energy Saver also conserves energy.

If you wish, you can use Energy Saver and a screen saver program. Set the screen saver to come on before Energy Saver. If your screen saver program includes its own energy-saving feature, you can turn off Energy Saver.

3

Using Your Monitor With Windows-Based Computers



This chapter describes how to install the ColorSync Display setup file and adjust the screen image on the ColorSync Display. In most cases, you won't need to adjust the image unless you make changes to screen resolution.

Note: If you're using the monitor with a Mac OS-based computer, refer to Chapter 2, "Installing and Using Apple Displays Software."

Installing ColorSync Display setup information for Windows

On Windows systems, new devices are automatically detected when they are connected to your computer (if it is VESA DDC compliant). If you are not using Windows, see the manual that came with your video card for setup information.

To determine that Windows has correctly identified your monitor, check Monitor Type in the Display Properties dialog box. Performing this check will ensure that the ColorSync Display setup information has been installed. Not installing the setup information may limit the resolution and refresh rates on your monitor.

To correctly identify the monitor type in your computer, follow these steps:

- 1** Open the Start menu and choose Settings.
- 2** Open the Control Panel and double-click the Display icon.

The Display Properties dialog box appears.

- 3** Click the Settings tab at the top of the dialog box.

The Settings property sheet appears.

- 4** Click the Change Display Type button in the lower-right corner to display the current Monitor Type.

If the Monitor Type shown is the ColorSync Display, your computer has correctly identified your monitor. Go to the next section, “Screen Controls at a Glance.”

If the Monitor Type shown is not the ColorSync Display, continue with step 5.

- 5** Click the Change button next to the Monitor Type field; then select ColorSync Display and click OK.

If the ColorSync Display is not one of the devices displayed, then the setup information file needs to be installed.

- 6** Insert the *Apple Displays Software* CD-ROM disc into your CD-ROM disc drive.

If you do not have a CD-ROM disc drive, see the service and support information that came with your monitor for information on how to order floppy disks.

- 7** Click the **Have Disk** button.
- 8** Choose the CD-ROM disc drive and click **OK**.

If an error occurs, make sure you've selected the correct disc drive.

- 9** Choose the **ColorSync Display** in the **Monitor Type** field and click **OK**.

You're now ready to use your monitor with your computer.

Screen controls at a glance

The buttons on the front of your monitor provide a quick way to adjust the screen image. In most cases, you won't need to adjust the screen image unless you make changes to screen resolution.

Use the following buttons to make screen image adjustments:

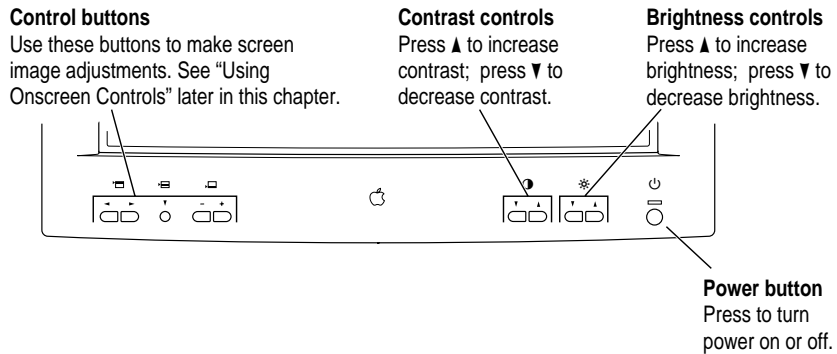

The contrast and brightness controls have an onscreen indicator that appears when you press the contrast and brightness control buttons on the front of your monitor. When you make an adjustment, the indicator bar moves to show the current setting. When you've finished making adjustments, the indicator disappears automatically.

Using onscreen controls

Your monitor comes with a set of onscreen controls you use to adjust the screen image.

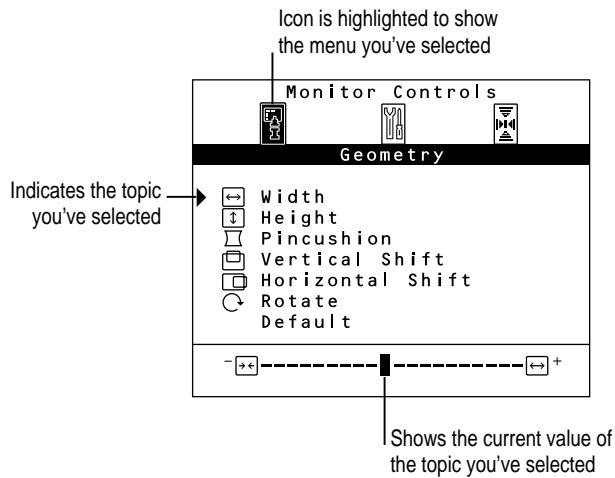

Use the buttons on the front of your monitor to open the Monitor Controls window and select topics from the menus.

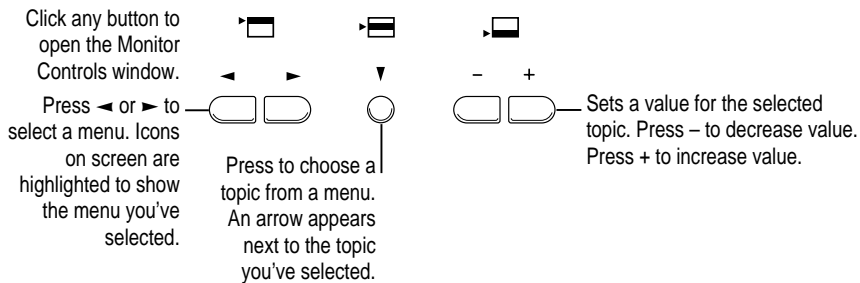

Adjusting screen geometry

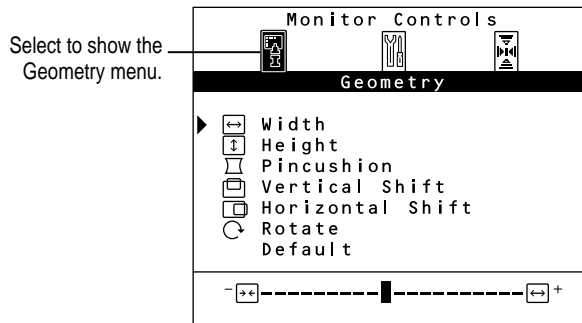

Select to show the Geometry menu.

Use the Geometry menu to adjust the height and width of the screen image, center the image on the screen, and so on.

Width

Adjusts the width of the screen image. Press – to decrease width. Press + to increase width. When the width and height of the screen image are set properly, you can see the entire image on the screen.

Height

Adjusts the height of the screen image. Press – to decrease height. Press + to increase height. When the height and width of the screen image are set properly, you can see the entire image on the screen.

Pincushion

Adjusts the shape of the screen image. Press – to bring in the sides of the image, changing the shape from convex to concave. Press + to expand the sides of the image, changing the shape from concave to convex. When the shape of the image is set properly, the left and right sides are straight and the image is rectangular.

Vertical Shift

Adjusts the vertical position of the screen image. Press – to move the image down. Press + to move the image up. When the screen image is centered properly, there is an equal border around all edges of the image.

Horizontal Shift

Adjusts the horizontal position of the screen image. Press – to move the image to the left. Press + to move the image to the right. When the screen image is centered properly, there is an equal border around all edges of the image.

Rotate

Rotates the screen image. Press – to rotate counterclockwise. Press + to rotate clockwise. When the rotation of the screen image is set properly, all four sides of the image are parallel to the edges of the screen and the image is rectangular.

Default

Returns screen adjustments to the preset factory values. Press the + button to turn defaults on.

Adjusting color settings and other features

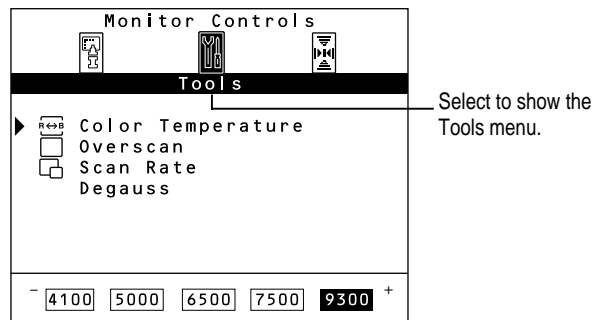

Use the Tools menu to set color temperature, turn overscan on and off, display the scan rate of your monitor, and manually degauss.

Color Temperature

Adjusts the color temperature of your monitor. The color temperature (or *white point*) you select for your monitor sets the mix of red, green, and blue light that makes the color white. This color temperature sets the foundation for other colors on your monitor.

The color temperature of your monitor can be changed to one of the following Kelvin temperatures: 4100 K, 5000 K, 6500 K, 7500 K, or 9300 K. (*Kelvin* is a temperature scale used in scientific applications.)

Press – to decrease color temperature. Press + to increase color temperature. Changing the color temperature changes the appearance of colors on the screen. Lower temperature settings create reddish whites, and higher temperature settings create bluer whites.

Overscan

Turns overscan on and off. Overscan moves the screen image as far to the edges of the screen as possible without distorting the image. Press – to turn overscan off. Press + to turn overscan on.

When overscan is on, you cannot make screen geometry adjustments such as horizontal shift, rotation, and so on.

Scan Rate

Shows the scan rate of the monitor. This setting is for informational purposes only; it's not for adjusting the scan rate.

Degauss

Manually degausses the monitor. Press + to degauss the monitor.

Adjusting convergence

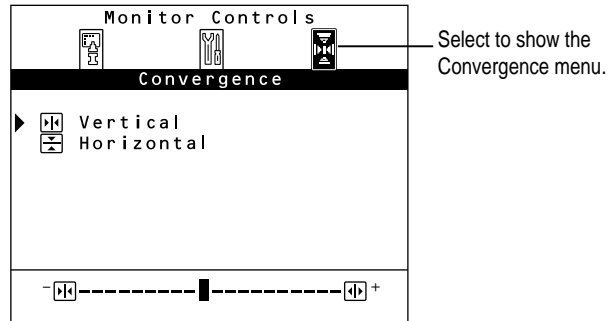

Red, green, and blue signals in your monitor converge to create the colors you see on your screen. If the convergence is not set properly, images or text on your screen may appear blurred, or you may get a “rainbow” effect with several colors forming the edges of images on the screen.

If your monitor is exposed to an external electromagnetic field (for example, from another monitor) over a period of time, you may need to change the convergence to get a clear, distinct screen image.

Use the Convergence menu to adjust screen convergence. When convergence is set properly, the image is clear and distinct.

Vertical

Adjusts the vertical convergence. Press – to move the red signal down and the blue signal up. Press + to move the red signal up and the blue signal down.

Horizontal

Adjusts the horizontal convergence. Press – to move the red signal to the right and the blue signal to the left. Press + to move the red signal to the left and the blue signal to the right.

4

Tips and Troubleshooting



This chapter includes information on the care and cleaning of your monitor, protecting your monitor from theft, and troubleshooting.

Care and cleaning

- Do not block the monitor's vents.
- Do not let liquid get on or into the monitor.
- If you will not be using your monitor and computer for a long period of time (a day or more), make sure you turn off the computer (and your monitor, if necessary).

To clean the case and screen of the monitor:

1 Turn your computer and monitor off.

2 Disconnect the monitor's power cord.

If the monitor's power cord is connected to a grounded wall outlet, disconnect the power plug from the outlet.

If the monitor's power cord is connected to the back of your computer, disconnect the monitor's power plug from the back of the computer.

3 Wipe the case surfaces lightly with a clean, soft cloth dampened with water.

Don't use aerosol sprays, solvents, or abrasives that might damage the finish on the case.



- 4 Use a mild, non-abrasive cleaner on a soft cloth and wipe the screen. Don't spray the cleaner onto the screen, because the liquid may drip inside the monitor.

WARNING Do not use a cleaner that contains alcohol or acetone. You might damage the screen.

Protecting your monitor from theft

The slot at the base of the monitor in the back is for connecting a security lock. It lets you attach a narrow, flexible cable that you can use to secure your monitor (and the rest of your computer system) to prevent theft. Security locks are available from an Apple-authorized dealer or service provider.

Troubleshooting common problems

This section contains descriptions of problems you might experience with your monitor as well as solutions to try. Problems related to the computer itself are covered in the manuals that came with your computer.

WARNING Never remove the cover from the monitor or you may come in contact with hazardous voltage levels capable of causing serious injury and possibly death.

WARNING If you have a problem with your monitor and nothing presented in this manual or in Apple Guide solves it, consult the service and support information that came with your monitor for instructions on how to contact an Apple-authorized service provider or Apple for assistance. If you attempt to repair the monitor yourself, any damage you may cause to the monitor will not be covered by the limited warranty on your monitor. Contact an Apple-authorized dealer or service provider for additional information about this or any other warranty question.

Monitor power and screen appearance

IMPORTANT Detailed instructions for Apple Displays software are provided in Macintosh Guide (called Mac OS Guide on some computers) and in Monitors & Sound Guide. For Windows users, detailed instructions about onscreen controls are provided in Chapter 3, “Using Your Monitor With Windows-Based Computers.”

The monitor’s power indicator light doesn’t come on.

- Make sure the monitor power button is turned on.
- Make sure the computer is turned on.

The monitor’s power indicator light won’t turn green unless your computer is on.

- Make sure an energy saver program isn’t active on the computer.

For the 20-inch monitor (19-inch VIS), the monitor’s indicator light is amber when an energy saver program is on. Also, it may take some time to wake up your computer after you use an energy saver. For the 17-inch monitor (16.1-inch VIS), the monitor’s indicator light is off in energy-saving mode.

- Make sure the power cord is plugged in properly.

If the monitor power cord is plugged into your computer, make sure your computer is on and the cord is firmly plugged in.

If the monitor power cord is plugged into a grounded wall outlet, make sure the cord is firmly plugged in. Check to see whether power to the outlet has been interrupted. You can test the outlet by plugging in something that you know works—like a desk lamp or radio. If the test appliance works, but the monitor doesn’t, contact an Apple-authorized dealer or service provider.

- Make sure the monitor cable is connected to your computer properly.
- Make sure the thumbscrews on the monitor cable are tightened securely.

No image appears on the screen and the monitor's power indicator light is on.

- Make sure the monitor cable is connected correctly to the computer.
- Make sure the thumbscrews on the monitor cable are tightened securely.
- Make sure the contrast (●) and brightness (☼) controls are set correctly. The contrast and brightness controls are on the front of your monitor.
- Restart your computer, holding down ⌘-Option AV. This resets the monitor to factory default settings.

The screen is dark or appears dim.

- Make sure that your computer and monitor are turned on.
- Make sure that the power cord and the monitor cable are securely connected at both ends.
- Increase the contrast and brightness of the screen image. The contrast (●) and brightness (☼) controls are on the front of your monitor.
- A screen saver that darkens your screen may be activated. Press any key on the keyboard to reactivate the monitor.
- On Mac OS-based computers, the Energy Saver option may be activated. Press any key on the keyboard to reactivate the monitor. In approximately 10 seconds, the monitor is reactivated.

Over time, you experience eyestrain.

- Adjust the screen contrast. In a bright room, contrast is usually best set at maximum; in a dim room, lower contrast is usually more comfortable. The contrast (●) controls are on the front of your monitor. Also, be sure to take occasional breaks to focus your eyes on a distant object.
- Adjust the color temperature or white point of the screen image. For most application programs, a white point of 9300 K is best. For Mac OS-based computers, click the Color button in the Monitors & Sound control panel and set a new white point. For Windows-based computers, open the Tools menu, select Color Temperature, and set a new white point.

Contrast (Ⓢ) and brightness (☼) controls on the front of the monitor don't appear to work.

- For Mac OS–based computers, your monitor may have the contrast (Ⓢ) and brightness (☼) controls disabled. Click the Color button in the Monitors & Sound control panel and select Preferences. Under Calibration Protection, make sure that the checkbox to disable contrast and brightness controls is not marked; then, click OK.

The screen doesn't dim when Energy Saver or other energy-saving software is on.

- Make sure the energy-saving software is installed properly and the amount of time you've set up to trigger it has passed. For Mac OS–based computers, see “Conserving Energy” in Chapter 2 for more information. For Windows-based computers, see the manual that came with your energy-saving computer.

The screen flickers.

- Make sure the monitor cable is connected firmly to the correct port on the back of the computer.
- The flickering could be caused by interference from a nearby power line or electrical equipment—for example, a radio, a microwave oven, or another computer. Try relocating nearby electrical equipment, or moving your computer and monitor.
- If you have more than one monitor attached to your computer, the monitors might be interfering with one another. Make sure you're using a shielded ADB connector cable. Move the monitors farther apart or set the monitors at an angle, so their screens are close and their back panels are farther apart. If, after moving the monitors more than 16 inches apart, you still see flickering, contact an Apple-authorized dealer or service provider.
- If you are using a video card that has a very low refresh rate (below 67 Hz), the monitor may flicker. You may be able to change the refresh rate for the card. If possible, use a 75 Hz setting. See the manual that came with your video card for more information.

There are one or two very thin gray lines across the screen, one near the top and the other near the bottom.

- This is a normal characteristic of the Trinitron color picture tube design. The lines do not appear in any documents you print.

The screen image is off-center.

- Adjust the center of the image. For Mac OS–based computers, click the Geometry button in the Monitors & Sound control panel and modify the Position setting. For Windows-based computers, select the Geometry menu; then, click Vertical Shift. Press – to move the screen down and + to move the screen up. Repeat the process for Horizontal Shift.

The screen image is tilted slightly to the left or right.

- Adjust the rotation of the screen image. For Mac OS–based computers, click the Geometry button in the Monitors & Sound control panel and modify the Rotate settings. For Windows-based computers, select the Geometry menu; then, click Rotate. Press – to rotate counterclockwise and + to rotate clockwise.

The screen image is too large or too small.

- Adjust the horizontal or vertical size of the screen image. For Mac OS–based computers, click the Geometry button in the Monitors & Sound control panel and modify the height/width settings. For Windows-based computers, select the Geometry menu; then, click Width. Press – to decrease width and + to increase width. Repeat the process for Height.
- Make sure overscan is off. For Mac OS–based computers, click the Geometry button in the Monitors & Sound control panel and select Off for Overscan. For Windows-based computers, select the Tools menu; then, click Overscan. Press – to turn off overscan.
- Try changing to another resolution. For Mac OS–based computers, click the Monitor button in the Monitors & Sound control panel and select another resolution. For Windows-based computers, see the manual that came with your computer or video card.

Images or text on your screen appear fuzzy or blurred.

- Adjust the horizontal or vertical convergence of the screen image. For Mac OS–based computers, click the Geometry button in the Monitors & Sound control panel and select Convergence to change settings. For Windows-based computers, select the Convergence menu; then, click Vertical. Press – to move the red signal down and the blue signal up. Press + to move the red signal up and the blue signal down. Then, click Horizontal. Press – to move the red signal to the right and the blue signal to the left. Press + to move the red signal to the left and the blue signal to the right.

The colors on your screen appear too blue, too yellow, or too red.

- Adjust the color settings, recalibrate the monitor, set a new white point, or reset the monitor to the default factory color settings. For Mac OS–based computers, click the Color button in the Monitors & Sound control panel to open color controls. For Windows-based computers, see “Adjusting Color Settings and Other Features” in Chapter 3 for more information.

The screen appears greenish, the screen image is blank or unreadable, or there is “snow” on the screen.

- Make sure the monitor cable is connected firmly to the correct port on the back of the computer.

There are wavy lines on the screen, creating an optical effect or moiré pattern.

- You may see a moiré pattern while in some resolutions, depending on the desktop pattern displayed on the screen (the black-and-white checkerboard pattern frequently causes moiré). For Mac OS–based computers, click the Monitor button in the Monitors & Sound control panel and change to another resolution. For Windows-based computers, see the manuals that came with your computer. To change the desktop pattern, see the manuals that came with your computer or, for Mac OS–based computers, also see Macintosh (or Mac OS) Guide for more information.

Your application program doesn’t recognize changes you make in resolution settings.

- Some application programs do not properly support resolution changes you make to your monitor. You may have to close and restart your program for it to recognize the resolution changes.

Monitors & Sound control panel for Mac OS–based computers

IMPORTANT Detailed instructions for Apple Displays software are provided in Macintosh Guide (called Mac OS Guide on some computers) and Monitors & Sound Guide.

The name of your monitor doesn't appear in the Monitors & Sound control panel.

- After you set up your monitor, make sure the monitor power is on and restart your computer.
- Make sure the ADB connector on the monitor cable is plugged directly into your computer's ADB port.
- Make sure you've installed the Apple Displays software that came with your monitor. See "Installing Apple Displays Software" in Chapter 2 for more information.
- You may be using a video card that's not compatible with your monitor. Contact the manufacturer of the video card for information.

A message appears, "This version of system software is not supported by the Apple Displays software."

- Make sure you're using System 7.5 or later.
- If this message appears in the Apple Displays Software Installer, make sure you select the startup hard disk in the Installation dialog box.

A message appears, "The AppleVision preferences are invalid and may have become corrupted."

- Delete the AppleVision preferences folder on your hard disk and restart your computer.

A message appears, "An error has occurred reading from or writing to a file."

- Make sure you are not starting up from a non-writable disk, such as a CD, a locked hard drive, or a floppy disk.

A message appears, “This monitor is not supported by this version of the Apple Displays software.”

- Make sure you have installed the Apple Displays software that came with your monitor. See Chapter 2, “Installing and Using Apple Displays Software,” for more information.

A message appears, “AppleVision failed to load,” followed by an error code.

- Make sure you’ve plugged the monitor connector and ADB connector on the monitor cable into the correct ports. You may have plugged them into the wrong ports by mistake. See “Connecting the Monitor Cable to a Mac OS–Based Computer” in Chapter 1 for more information.
- Make sure your video card supports the ColorSync Display. See the manual that came with your video card or computer.
- Some viruses can cause problems with the Apple Displays software. Make sure you regularly scan your computer for viruses.
- If Apple Displays software is installed and you start up your computer holding the Shift key down, the Display Enabler extension will not load and the software will not run. Restart your computer without disabling extensions to use the Apple Displays software.
- If none of the suggestions solves the problem, reinstall the Apple Displays software.

The Monitors & Sound control panel opens, but does not include the Geometry or Color button.

- Make sure the ADB connector on the monitor cable is plugged directly into your computer’s ADB port.
- Reinstall the software that came with your monitor. See Chapter 2, “Installing and Using Apple Displays Software,” for more information.

ColorSync Profile files are not updated when ColorSync software is installed.

- Out-of-date profiles in the ColorSync Profiles folder are not removed automatically. If you want to remove a ColorSync profile, you must do so manually. See Appendix A, “Using ColorSync Software,” for more information about ColorSync software.

Your ColorSync monitor appears as a VGA monitor in the Control Strip pop-up menus.

- Make sure the ADB connector on the monitor cable is plugged directly into your computer's ADB port.
- Reinstall the software that came with your monitor. See Chapter 2, "Installing and Using Apple Displays Software," for more information.

You hear no alert sound.

- Make sure the alert volume control is set correctly. Click the Alerts button in the Monitors & Sound control panel and reset the System Alert Volume.

Your third-party driver no longer shows up in your Monitors & Sound control panel.

- Some Mac OS–based sound drivers require the Sound control panel, an older control panel that has been replaced on your computer by the Monitors & Sound control panel. You can reinstall the Sound control panel. Open the Apple Extras folder on your hard disk and double-click the Apple Displays Extras folder. Double-click the Sound control panel icon.

Changes in the Monitors & Sound control panel don't work for the monitor.

- Make sure you have installed the software that came with your monitor.
- Because each monitor connected to your computer has its own Monitors & Sound window, use the window that displays the name of your monitor in the top-left corner.

When you open the Monitors & Sound control panel, only one resolution is available.

- Make sure you have connected the ADB connector to your computer. You cannot use many of the features of the Apple Displays software without an ADB connection. See "Connecting the Monitor Cable to a Mac OS–Based Computer" in Chapter 1 for more information.
- If Apple Displays software is installed and you start up your computer holding the Shift key down, the Display Enabler extension will not load and the software will not run. Restart your computer without disabling extensions to use the software.
- Reinstall the software that came with your monitor. See Chapter 2, "Installing and Using Apple Displays Software," for more information.

When you turn on overscan, it stays on even when you change resolutions.

- This is a new feature of the ColorSync Display 20" (19" VIS). In other ColorSync monitors, overscan automatically turns off when you change resolution settings.

No colors appear on the screen.

- Check to make sure that the number of colors is set correctly in the Control Strip or in the Monitors & Sound control panel.

No colors appear when you create a custom white point.

- Make sure the color depth on your monitor is set to “Thousands of Colors” or “Millions of Colors.” Click the Monitor button in the Monitors & Sound control panel and reset the color depth, or use the Control Strip to change settings.

You do not have a CD-ROM disc drive for installing the Apple Displays software.

- You can order a set of floppy disks of the Apple Displays software. See the service and support information that came with your monitor for more information. Support information and Apple software updates are also available via Apple’s World Wide Web sites: <http://www.info.apple.com> and <http://www.support.apple.com>.



Appendix B Technical Information

Picture tube

- *ColorSync Display 17"*: 17-inch (16.1-inch diagonal viewable image size) Trinitron CRT
- *ColorSync Display 20"*: 20-inch (19.0-inch diagonal viewable image size) Trinitron CRT

Screen

- 0.26 millimeter (mm) stripe pitch

Input signals

- Red, green, and blue video signals
- Multiple scan
- Separate Horizontal and Vertical Sync (DDC 1/2B)
- DDC clock and data signals
- *Vertical Refresh*: 40 hertz (Hz) to 120 Hz (ColorSync Display 17" [16.1" VIS]); 48 Hz to 120 Hz (ColorSync Display 20" [19" VIS])
- *Horizontal Scan*: 30 kilohertz (kHz) to 80 kHz (ColorSync Display 17" [16.1" VIS]); 30 kHz to 94 kHz (ColorSync Display 20" [19" VIS])

Power-saving and environmental features

- NUTEK compliant

ColorSync monitors are equipped with energy-saving features that allow the monitors to conserve energy when the computer is not in use.

| DPMS mode | Mac OS Energy Saver mode | Power consumption* | Power indicator* |
|-----------|--------------------------|------------------------------|-----------------------------|
| On | Normal | <125 W (17") <150 W (20") | Green (17") Green (20") |
| Standby | Display sleep | <60 W (17") <30 W (20") | Green (17") Orange (20") |
| Suspend | — | <30 W (17") <15 W (20") | Green (17") Orange (20") |
| Off | System sleep | 0 W (17") <5W (20") | Off (17") Orange (20") |

*The 17-inch monitor has a 16.1-inch diagonal viewable image size; the 20-inch monitor has a 19-inch diagonal viewable image size.

For instructions on adjusting the system and monitor sleep settings, and additional energy-conservation information, see “Conserving Energy” in Chapter 2.

- TCO 95 compliant

This product has been certified by TCO (the Swedish Confederation of Professional Employees) to have met global safety standards and power-saving features, such as automatic monitor power-down and reduced electromagnetic fields.

- MPR II compliant

This product has reduced electromagnetic and electrostatic emissions.

- Energy Star compliant

This product complies with the United States Environmental Protection Agency’s (EPA) Energy Star criteria for energy-efficient office products. The EPA Energy Star Office Equipment program is a partnership program to promote energy-efficient personal computers, monitors, printers, fax machines, and copiers. Reducing the energy consumption from this equipment can help combat smog, acid rain, and climate change by decreasing emissions from electricity generation.

- DPMS compliant

This product's power-saving features comply with the Video Electronics Standards Association (VESA) Display Power Management Signaling (DPMS). (Connected CPU must also be VESA DPMS compliant to use DPMS features.)

User controls

- Power-on button
- Automatic degauss at power-up; manual degauss by turning power switch off, then on
- *Control buttons:* Contrast, brightness, and five buttons for onscreen controls
- Additional screen controls available using the Monitors & Sound control panel (Mac OS-based computers) or onscreen controls (Windows-based computers)

Factory preset timings (ColorSync Display 17" [16.1" VIS])

- Adjusted at the factory for the following standard modes:

| Mode | Resolution | Vertical refresh rate (hertz) | Horizontal scan rate (kilohertz) |
|-----------|-------------|-------------------------------|----------------------------------|
| VGA | 640 x 480 | 60 | 31.5 |
| Macintosh | 640 x 480 | 66.67 | 34.97 |
| VESA | 800 x 600 | 60.31 | 37.9 |
| VESA | 800 x 600 | 75 | 46.9 |
| Macintosh | 832 x 624 | 74.55 | 49.7 |
| Macintosh | 1024 x 768 | 74.93 | 60.24 |
| Macintosh | 1152 x 870 | 75 | 68.7 |
| VESA | 1024 x 768 | 60 | 48.4 |
| VESA | 1280 x 1024 | 60 | 64.3 |
| VESA | 1280 x 1024 | 75.03 | 79.98 |

Factory preset timings (ColorSync 20" [19" VIS])

- Adjusted at the factory for the following standard modes:

| Mode | Resolution | Vertical refresh rate (hertz) | Horizontal scan rate (kilohertz) |
|-----------|-------------|-------------------------------|----------------------------------|
| VGA | 640 x 480 | 60 | 31.469 |
| Macintosh | 640 x 480 | 67 | 35.036 |
| VESA | 640 x 480 | 72 | 37.861 |
| VESA | 640 x 480 | 75 | 37.500 |
| VESA | 640 x 480 | 85 | 43.269 |
| VESA | 800 x 600 | 56 | 35.160 |
| VESA | 800 x 600 | 60 | 37.879 |
| VESA | 800 x 600 | 72 | 48.077 |
| VESA | 800 x 600 | 75 | 46.875 |
| VESA | 800 x 600 | 85 | 53.674 |
| Macintosh | 832 x 624 | 75 | 49.700 |
| IBM | 1024 x 768 | 87 interlaced | 35.522 interlaced |
| VESA | 1024 x 768 | 60 | 48.363 |
| VESA | 1024 x 768 | 70 | 56.476 |
| VESA | 1024 x 768 | 75 | 60.023 |
| VESA | 1024 x 768 | 85 | 68.677 |
| Macintosh | 1152 x 870 | 75 | 68.700 |
| VESA | 1280 x 1024 | 75 | 79.976 |
| VESA | 1280 x 1024 | 85 | 91.146 |
| VESA | 1600 x 1200 | 75 | 93.750 |

Input electrical requirements

- *Voltage:* 100–240 V
- *Frequency:* 50–60 Hz
- *Power:* 130 W maximum (ColorSync Display 17" [16.1" VIS]); 150 W maximum (ColorSync Display 20" [19" VIS])

Weight

- *ColorSync Display 17" (16.1" VIS)*: Approximately 50 pounds (23 kilograms)
- *ColorSync Display 20" (19" VIS)*: Approximately 67 pounds (30 kilograms)

Dimensions

- *Height*: 425 millimeters (mm) ± 3 mm (*ColorSync Display 17" [16.1" VIS]*); 474 millimeters (mm) ± 3 mm (*ColorSync Display 20" [19" VIS]*)
- *Width*: 410 mm ± 3 mm (*ColorSync Display 17" [16.1" VIS]*); 484 mm ± 3 mm (*ColorSync Display 20" [19" VIS]*)
- *Depth*: 455 mm ± 3 mm (*ColorSync Display 17" [16.1" VIS]*); 515 mm ± 3 mm (*ColorSync Display 20" [19" VIS]*) (not including cables)

Interfaces

- Apple Desktop Bus (ADB): Two ADB pass-through output ports

Color compatibility

- Works with ColorSync software version 2.1 or higher. ColorSync profiles are compatible with the profile specifications of the International Color Consortium (ICC).

Temperature

Celsius (C) and Fahrenheit (F)

- Operating 10° to 40° C (50° to 104° F)
- Storage 0° to 60° C (32° to 140° F)
- Shipping -40° to 60° C (-4° to 140° F)

| Humidity (noncondensing) | 17" (16.1" VIS) | 20" (19" VIS) |
|--------------------------|-----------------|---------------|
| Operating | 10% to 80% | 20% to 95% |
| Storage | 5% to 90% | 5% to 95% |
| Shipping | 5% to 90% | 5% to 95% |

Altitude

- Operating 0 to 10,000 feet (ft.)
0 to 3048 meters (m)
- Shipping 0 to 35,000 ft.
0 to 10,670 m

Display cable specifications

- 15-pin miniature D-type connector

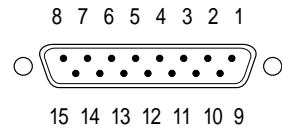

| Pin | Signal |
|-------|---------------------------|
| 1 | Red video ground |
| 2 | Red video |
| 3 | Not used |
| 4 | ID 1/DDC RTN |
| 5 | Green video |
| 6 | Green video ground |
| 7 | ID 2/DDC SCL |
| 8 | DDC 5V (not used for 17") |
| 9 | Blue video |
| 10 | ID 3/DDC SDA |
| 11 | Vertical Sync return |
| 12 | Vertical Sync |
| 13 | Blue video ground |
| 14 | Horizontal Sync return |
| 15 | Horizontal Sync |
| Shell | Shield ground |

VGA adapter specifications

- Standard 15-pin VGA connector

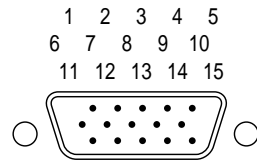

| Pin | Signal |
|-------|---------------------------|
| 1 | Red video |
| 2 | Green video |
| 3 | Blue video |
| 4 | Monitor ID 2 |
| 5 | DDC return |
| 6 | Red return |
| 7 | Green return |
| 8 | Blue return |
| 9 | DDC 5V (not used for 17") |
| 10 | Sync return |
| 11 | Monitor ID 0 |
| 12 | SDA (ID 1) |
| 13 | Horizontal Sync |
| 14 | Vertical Sync |
| 15 | SCL (ID 3) |
| Shell | Shield ground |